

FORT DODGE ANIMAL HEALTH

Division of Wyeth, a subsidiary of Pfizer, Inc.

235 E. 42ND ST., NEW YORK, NY, 10017

Telephone: 269-833-4000

Customer Service: 800-733-5500 and 800-793-0596

Veterinary Medical Investigations & Product Support: 800-366-5288

Technical Services (USA): 800-366-5288

Website: <http://pfizerah.com>

SYNOVEX® C

Fort Dodge

CALF IMPLANTS

For Increased Rate of Weight Gain

NADA 9-576, Approved by FDA

Each dosage consists of 4 pellets containing 100 mg progesterone and 10 mg estradiol benzoate per implantation. This product was manufactured by a non-sterilizing process.

Synovex C Calf Implants contain two pure steroid hormones, progesterone and estradiol benzoate. This formulation provides a complementary amount of each hormone for maximal growth stimulation. Study the enclosed instructions carefully and use this product only as illustrated.

Important: Read ALL sides of carton

Do Not Use In Veal Calves

Not For Use In Humans

For Animal Use Only

For subcutaneous ear implantation only.

HOW TO IMPLANT WITH SYNOVEX® PELLETS

Study the following instructions carefully, then proceed step by step, until the technique becomes routine. Many head can be implanted per hour by an experienced team, one member of which should be assigned to do nothing but the implantation. This person should maintain hand cleanliness and use sanitary instruments only.

SYNOVEX[®] C Implants

Synovex C is recommended for use in suckling beef calves up to approximately 400 lbs of body weight. Synovex C is also recommended for improvement in rate of weight gain in steers weighing greater than 400 pounds and fed in confinement for slaughter when used as part of a re-implant program in which an initial Synovex C implant is followed at approximately 70 days by Synovex S. Do not use in veal calves. Effectiveness and animal safety in veal calves have not been established.

Do not use in bull calves intended for reproduction, or in calves less than 45 days old.

Store at controlled room temperature 15° to 30°C (59° to 86°F). Avoid excessive heat or humidity.

DIRECTIONS: Implant complete contents of one cartridge cell per calf at each implanting. Approved implantation technique is fully described in the package insert.

NOTE: Never sacrifice careful, clean technique for speed of implantation.

WARNING

▶ Not for use in humans. For animal use only. Implant pellets in the ear only. Any other location is in violation of federal law. Do not attempt salvage of implanted site for human or animal food. ◀

A withdrawal period has not been established for this product in pre-ruminating calves. Do not use in calves to be processed for veal.

CAUTION

Bulling, rectal and vaginal prolapse, udder development, ventral edema and elevated tailheads may be reported in calves administered with Synovex C implants.

Keep this and all drugs out of the reach of children.

Restricted Drug (California) - Use Only as Directed.

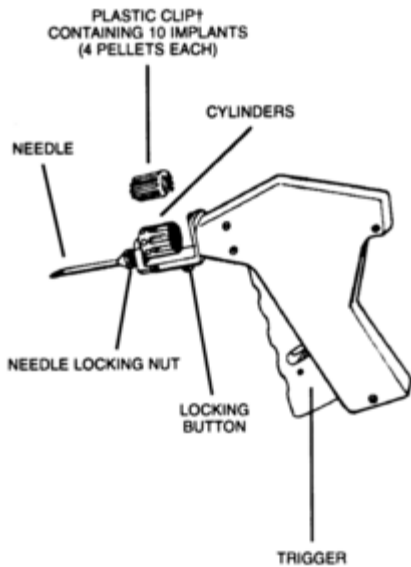

†U.S. Patent No. 4,400,170

STEP 1 Loading the SYNOVEX Gun

Load the Synovex gun following the directions outlined in the instruction manual accompanying each Synovex gun.

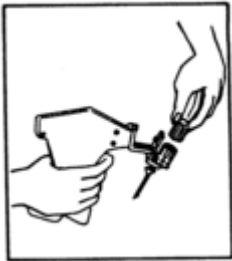

STEP 2 Restraint

The animal must be confined in a restraint mechanism (squeeze gate or head gate). The implant site on the back of the ear should be prepared by scrubbing with a generous-sized piece of cotton that has been soaked in a germicidal solution.

Note: If implanting horned cattle, greater safety is provided when the head is controlled by the use of a bull lead (nose tongs).



STEP 3 Implant Site

Divide the ear into three imaginary sections as illustrated. The implanted pellets should be deposited in the center one-third of the ear as shown. To accomplish this, the Synovex gun needle should be inserted in the **outer** one-third of the ear as indicated by the “X” in the illustration. Implanting too close to the head may cause abnormal sexual behavior. Care should be taken to avoid severing the major arteries of the ear.

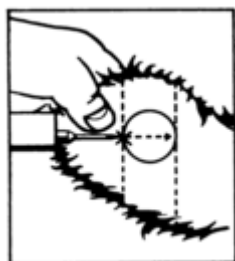

STEP 4 Insert Needle

Grasp the ear with one hand. Holding the Synovex gun firmly with the other hand, penetrate the skin at the point shown by the “X”. Thrust the needle under the skin taking care not to penetrate the cartilage. Ease the Synovex gun forward (toward the base of the ear) until the full needle length is beneath the skin.

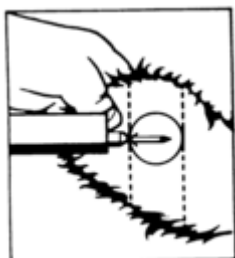

STEP 5 Pellet Implantation

When the needle is completely inserted, withdraw the needle approximately one-half inch. Then with continuous gentle pressure on the trigger, expel the pellets while continuing to slowly withdraw the needle. This technique allows the pellets to be deposited in a straight line in the path of the needle.

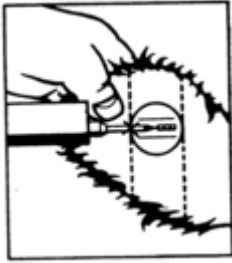

STEP 6 Inspection

Check the implant site. If properly administered, the implants should lie in a straight line under the skin.

Disinfect the Synovex gun needle in a germicidal solution. You are now ready to implant the next animal.

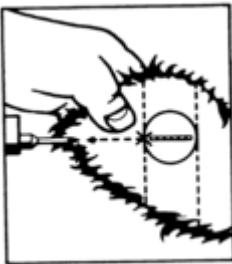

SYNOVEX® SX10® Gun

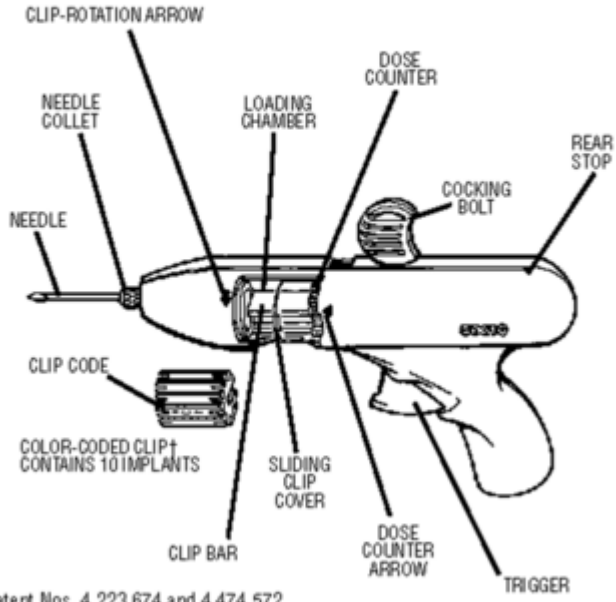

* U.S. Patent Nos. 4,223,674 and 4,474,572
 † U.S. Patent No. 4,400,170

STEP 1 Loading The SX10 Gun

Load the SX10 gun following the directions outlined in the instruction manual accompanying each SX10 gun.

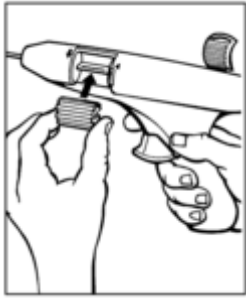

STEP 2 Restraint

The animal must be confined in a restraint mechanism (squeeze chute or head gate). The implant site on the back of the ear should be prepared by scrubbing with a generous-sized piece of cotton that has been soaked in a germicidal solution.

Note: If implanting horned cattle, greater safety is provided when the head is controlled by the use of a bull lead (nose tongs).



STEP 3 Implant Site

Divide the ear into three imaginary sections as illustrated. The implanted pellets should be deposited in the center one-third of the ear as shown. To accomplish this, the SX10 gun needle should be inserted in the **outer** one-third of the ear as indicated by the “X” in the illustration. Implanting too close to the head may cause abnormal sexual behavior. Care should be taken to avoid severing the major arteries of the ear.

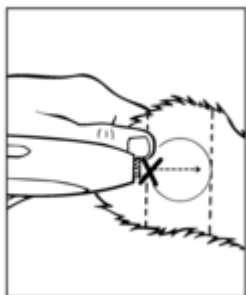

STEP 4 Insert Needle

Just before grasping the ear with one hand, release the safety by striking the butt of the gun. Holding the SX10 gun firmly with the other hand, penetrate the skin at the point shown by the “X”. Thrust the needle under the skin taking care not to penetrate the cartilage. Ease the SX10 gun forward (toward the base of the ear) until the full needle length is beneath the skin.

STEP 5 Pellet Implantation

When the needle is completely inserted, activate the instrument by squeezing the trigger completely. **Do not withdraw the needle**, but allow the automatic needle retractor to release the pellets. This will allow the pellets to be deposited in a straight line in the path of the retracted needle.

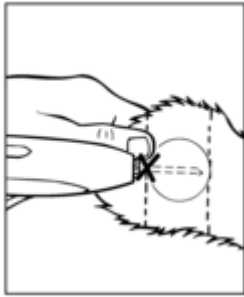

STEP 6 Inspection

Check the implant site. If properly administered, the implants should lie in a straight line under the skin.

Disinfect the SX10 gun needle in a germicidal solution and recock the instrument by rotating the cocking grip left, pull back, rotate right, then push all the way forward. You are now ready to implant the next animal.

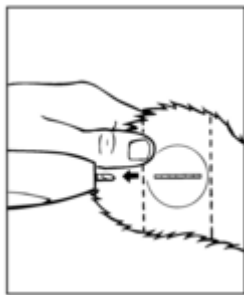

HOW SUPPLIED

NDC 0856-3903-02 - 2 cartridges (20 Dose)

NDC 0856-3903-43 - 10 cartridges (100 Dose)

Each Cartridge Contains 10 Rows of 4 Pellets.

© 2004 Fort Dodge Animal Health. All Rights Reserved.

Fort Dodge Animal Health, Fort Dodge, Iowa 50501 USA

02474

6034C, 6033D

NAC No.: 10032141